

SEC 3100 Transmitter



Instruction and Operation Manual

Sensor Electronics Corporation
12730 Creek View Avenue
Savage, Minnesota 55378 USA
(952) 938-9486 Fax (952) 938-9617
Web site www.sensorelectronics.com

Part Number 3100-EXP-MANUAL
REV 11, 20141007

Sensor Electronics Corporation

Sensor Electronics Corporation (SEC) designs and manufactures innovative fixed system gas detection equipment, for combustible gases, oxygen, carbon dioxide and toxic gases.

Commitment

Our quality and service are uncompromising. We back each of our products with a two-year warranty on all materials and workmanship. We offer technical support, user training and on-site service and maintenance of equipment to meet the needs of our customers.

Gas Detection Service

Individually designed maintenance packages are available for specific customer needs. Service begins with verification of the system installation that includes an initial system check and calibration. We then offer customer training programs (on-site and at factory) to insure that technical personnel fully understand operation and maintenance procedures. When on-the-spot assistance is required, service representatives are available to handle any questions or problems immediately.

WARRANTY

SENSOR ELECTRONICS CORPORATION (SEC) WARRANTS PRODUCTS MANUFACTURED BY SEC TO BE FREE FROM DEFECTS IN WORKMANSHIP AND MATERIALS FOR A PERIOD OF TWO (2) YEARS FROM DATE OF SHIPMENT FROM THE FACTORY. ANY PARTS RETURNED FREIGHT PRE-PAID TO THE FACTORY AND FOUND DEFECTIVE WITHIN THE WARRANTY WOULD BE REPAIRED OR REPLACED, AT SEC'S OPTION. SEC WILL RETURN REPAIRED OR REPLACED EQUIPMENT PRE-PAID LOWEST COST FREIGHT. THIS WARRANTY DOES NOT APPLY TO ITEMS, WHICH BY THEIR NATURE ARE SUBJECT TO DETERIORATION OR CONSUMPTION IN NORMAL SERVICE. SUCH ITEMS MAY INCLUDE:

**CHEMICAL SENSOR ELEMENTS
FUSES AND BATTERIES.**

WARRANTY IS VOIDED BY ABUSE INCLUDING ROUGH HANDLING, MECHANICAL DAMAGE, ALTERATION OR REPAIR. THIS WARRANTY COVERS THE FULL EXTENT OF SEC LIABILITY AND SEC IS NOT RESPONSIBLE FOR REMOVAL, REPLACEMENT COSTS, LOCAL REPAIR COSTS, TRANSPORTATION COSTS OR CONTINGENT EXPENSES INCURRED WITHOUT PRIOR WRITTEN APPROVAL. SENSOR ELECTRONICS CORPORATION'S OBLIGATION UNDER THIS WARRANTY SHALL BE LIMITED TO REPAIR OR REPLACEMENT OF ANY PRODUCT THAT HAS BEEN RETURNED TO SENSOR ELECTRONICS CORPORATION FOR WARRANTY CONSIDERATION. THIS WARRANTY IS EXPRESSLY IN LIEU OF ANY AND ALL OTHER WARRANTIES EXPRESSED OR IMPLIED, AND ALL OTHER OBLIGATIONS OR LIABILITIES ON THE PART OF SENSOR ELECTRONICS CORPORATION INCLUDING BUT NOT LIMITED TO, THE FITNESS FOR A PARTICULAR PURPOSE. IN NO EVENT SHALL SENSOR ELECTRONICS CORPORATION BE LIABLE FOR DIRECT, INCIDENTAL, OR CONSEQUENTIAL LOSS OR DAMAGE OF ANY KIND CONNECTED WITH THE USE OF IT'S PRODUCTS OR FAILURE TO FUNCTION OR OPERATE PROPERLY.

Table of Contents

I. SPECIFICATIONS

II. GENERAL DESCRIPTION

III. OPERATION

Installation and Startup
Fault Codes

IV. MAGNETIC SWITCH OPERATION

V. FIGURES

Figure 1 – Overall Layout

Figure 2 – SEC 3100 Wiring

Figure 3 – SEC Sensor Separation Kit

I. SPECIFICATIONS

Model:

SEC 3100 Transmitter

For use with:

SEC Millenium and SEC Signature series infrared sensors and SEC 3000 Toxic and Oxygen gas sensors.

Part Number: SEC 3100-XXX-XXXXXX

Output (analog):

4-20 mA (Source type), max. 1000 Ohm load at 24 VDC supply voltage

Output (digital):

RS485 LAN (isolated)

Output (relays):

Three (3) Alarm, Low, Mid High. One (1) Fault
Rated for 8 Amps 30 VDC or 220VAC

Display:

LCD (backlit)

Construction:

Epoxy coated aluminum

Operating Temperature Rating:

-40° to +140° F at 0 to 99% RH (non-condensing)
(-40° to +60°C)

Operating Voltage:

24 VDC

Operating range: 18 to 30 VDC measured at the detector head

Max. Current Draw: (at 24 VDC with sensor)

Average: 250 mA

Peak: 500 mA

Approvals:

cCSAus Certificate: 1513912 (LR9549)

Class I, Division 1, Groups B,C,D T5

IECEX Certificate: CSA12.0012

Ex-d IIB+H2, T5 Gb

II GENERAL DESCRIPTION

CONVENTIONS

The following conventions are used in this manual.



Warning Statement



VDC (DC Voltage)

SEC 3100

The SEC 3100 transmitter is designed to be used with the SEC Millennium, SEC Signature infrared gas sensors or SEC 3000 toxic gas detectors. The SEC 3100 is a microprocessor based intelligent transmitter continuously monitoring information from the gas sensor. The LCD of the SEC 3100 displays the gas concentration and sensor status. The SEC 3100 has one (1) "Alarm" LED and one (1) "Status" LED. The SEC 3100 also has three (3) magnetic switches located around the circumference of the unit. This manual will describe the operation and use of the SEC 3100 transmitter.

Features

- *Explosion Proof*
- *Back lighted LCD Display*
- *Low Cost*
- *Plug and play toxic, oxygen and combustible gas sensors*
- *Self-check system*
- *4-20 mA output*
- *RS-485 Interface (Isolated)*
- *Optional alarm and fault relays*
- *Non-intrusive programming*
- *Non-intrusive calibration*
- *Removable, non-volatile, time stamped data logging*
- *Optional IS barrier*
- *Digital communication link to SEC 3000 and SEC Millennium Gas Detectors*
- *Multi port housing for easy installation*

III. OPERATION

Installation and Startup



Warning: The user shall be made aware that if the equipment is used in a manner not specified by the manufacturer, the protection provided by the equipment may be impaired.

The first step in the installation process is to establish a mounting location for the SEC 3100 transmitter and gas sensor. Select a location that is typical of the atmosphere to be monitored or close to the anticipated source of a dangerous gas.

It is very important that the SEC 3100 and gas sensor be properly located enabling it to provide maximum protection. The most effective number and placement of sensors vary depending on the conditions of the application. When determining where to locate gas sensors the following factors should be considered.

- What are the characteristics of the gas that is to be detected? Is it lighter or heavier than air? If it is lighter than air the sensor should be placed above the potential gas leak. Place the sensor close to the

floor for gases that are heavier than air. Note that air currents can cause a gas that is heavier than air to rise. In addition, if the temperature of the gas is hotter than ambient air or mixed with gases that are lighter than air, it could also rise.

- How rapidly will the gas diffuse into the ambient air? Select a location for the sensor that is close to the anticipated source of a gas leak.
- Wind or ventilation characteristics of the immediate area must also be considered. Movement of air may cause gas to accumulate more heavily in one area than in another. The detector should be placed in the areas where the most concentrated accumulation of gas is anticipated. For outdoor applications with strong wind conditions, it may require the sensors to be mounted closer together and on the down wind side, to the anticipated area of a gas leak. Also take into consideration for indoor applications, the fact that many ventilation systems do not operate continuously.
- The sensor should be accessible for maintenance.
- Excessive heat or vibration can cause premature failure of any electronic device and should be avoided if possible.
- Follow all national and local installation codes and practices.

The SEC 3100 has three (3) $\frac{3}{4}$ " NPT threaded connectors for mounting and wiring the sensor and transmitter into a permanent installation.

Field wiring connections are made on the backside of the SEC 3100 printed circuit board (PCB). For wiring details refer to Figure 2 in the back of the manual.

Power wire sizing:

0 to 500 feet, recommended wire gauge size 16 AWG

501 to 1000 feet, recommended wire gauge size 14 AWG

Shielded cable is recommended. Wiring should be installed in metal conduit with no other cabling in the same conduit.

Warm-up

When power is applied to the SEC 3100, it enters a one (1) minute warm-up mode. The output current will be 0.8 mA during the warm up time period. At the end of the warm-up period with no faults present, the SEC 3100 automatically enters the normal operating mode (4.0 mA with no gas present). If a fault is present after warm-up, the detector current output and LCD will indicate a fault. The Fault LED will also indicate the fault.

Normal

In the normal operating mode, the 4 to 20 mA signal levels correspond to the detected gas concentration. The transmitter continuously checks for and displays system faults or initiation of calibration and automatically changes to the appropriate mode.

The 4 to 20 mA output of the SEC 3100 sensor is a non-isolated current source.

Current Output and Corresponding Status

Current Output	Status
0-20 mA	Normal measuring mode
0.0 mA	Unit Fault
0.2 mA	Reference channel fault
0.4 mA	Analytical channel fault
0.8 mA	Unit warm up
1.0 mA	Optics fault
1.2 mA	Zero drift fault
1.6 mA	Calibration fault
2.0 mA	Unit spanning
2.2 mA	Unit zeroing
4.0 mA	Zero gas level (0% of full scale)
5.6 mA	(10% of full scale)
8.0 mA	(25% of full scale)
12 mA	(50% of full scale)
16 mA	(75% of full scale)
20 mA	Full scale (100% of full scale)
20.1- 23 mA	Over-range (> 100% of full scale)

Once the fault is cleared the SEC 3100 will automatically resume normal operation.

Flash Rate	Output Current	Unit Status Label	Possible Problem
1	4-20ma	Unit Running	Unit is measuring gas and adjusting 4-20ma output accordingly.
2	2.2ma	Unit Zero Calibrating	Unit going through its <i>zero calibration</i> procedure.
3	2.0ma	Unit Spanning	Unit going through its <i>spanning</i> procedure.
5	0.8ma	Unit Warm-up	Only for one minute after unit power-up
6	0.0ma	Power-up Fault	Hard Fault (refer to gas sensor manual)
7	1.6ma	Calibration Fault	<ol style="list-style-type: none"> 1. Attempt <i>Unit Span</i> with no gas 2. Attempt <i>Unit Zero</i> with gas
8	NA	NA	Currently Not Used
9	0.0ma	Unit Fault	Hard Fault (refer to gas sensor manual)
10	1.0ma	Optics Fault	Clean sensor's windows
11	1.2ma	Zero Drift Fault	Hard Fault (refer to gas sensor manual)
12	0.0ma	Configuration Fault	Hard Fault (refer to gas sensor manual)
16	0.2ma	Reference Channel Fault	Hard Fault (refer to gas sensor manual)
17	0.4ma	Active Channel Fault	Hard Fault or <i>Unit Zero</i> with gas

IV. MAGNETIC SWITCH OPERATION

The SEC 3100 has three (3) magnetic switch pickups on the Display PCB. The picture below shows the location of the magnetic switches labeled UP, DOWN and ENTER. Placing a magnet in close proximity to one of the switches will cause the following operations to occur.

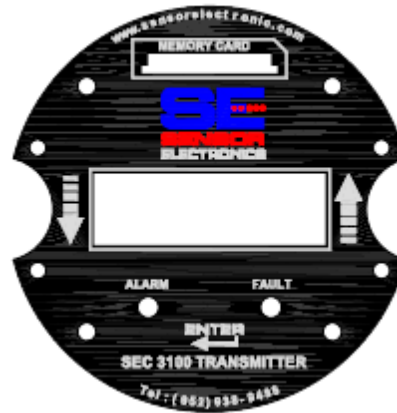

Switch	Operation
ENTER	Enter Menu Mode, Selects a menu to Enter
UP	Moves up through Menu selections
DOWN	Moves down through Menu selections

For further details on gas sensor calibration refer to the appropriate SEC sensor instruction manual.

The LCD contrast potentiometer, (POT1) is located under the protective faceplate shown above on the front side (LCD side) of PCB to the left of the LCD.

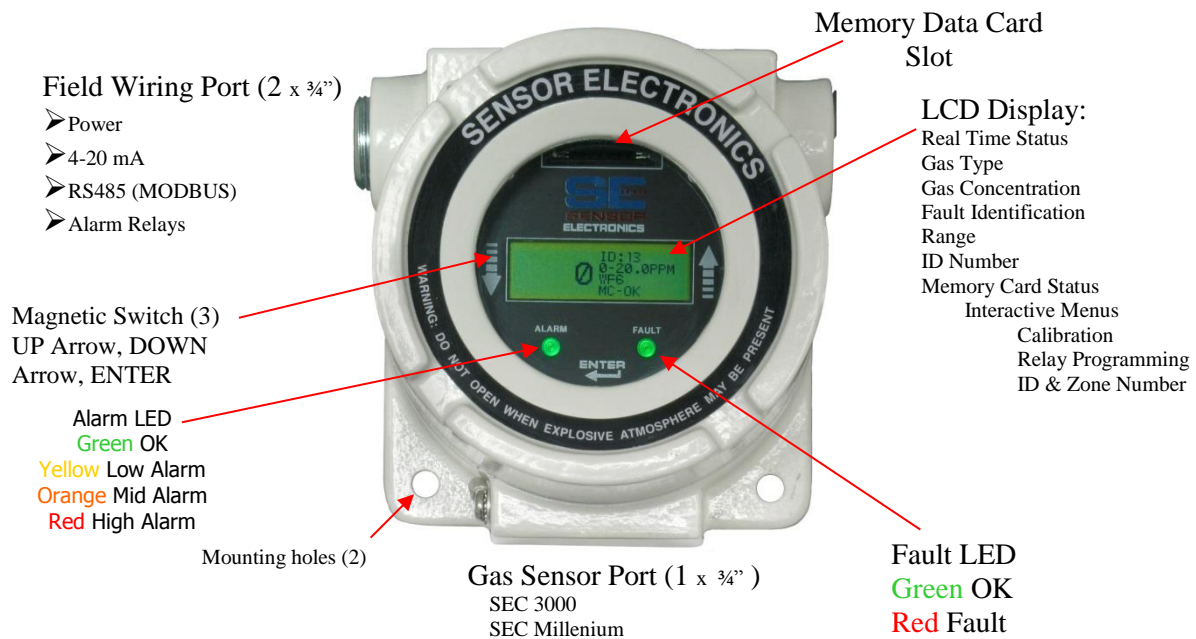

V. MENU OPERATION

Initial Power Up Sequence of the SEC 3100

```
SYSTEM BOOT PROCESS
--- WAIT FOR SYNC ---
```

```
SYSTEM BOOT PROCESS
-WAIT FOR SENSOR -
```

```
INITIALIZING
```

```
WARM          ID: xx
UP            SN: xxxxx
             TYP: x.x
             VER: x.x
```

```
WARM          ID: xx
UP            0-20.0PPM
             WF6
             ENT TO ABORT
```

```
0            ID: 1
             0-20.0 PPM
             WF6
             MC - REMOVED
```

In normal operating mode. Actual gas concentration will be displayed to the left of ID #, Range, Gas Type, MC (Memory Card) status.

During Warm Up, FAULT LED will be solid Blue and ALARM LED will be flashing Yellow – Blue.

MC – REMOVED indicates the MEMORY CARD (MC) is not installed in the SEC 3100. Other MC indications are OK, FAULT, FULL.

Selecting Enter when the SEC 3100 is in normal operating mode will advance to the following display:

```
* EJECT MEMORY CARD
INFO
MAIN MENU
EXIT
```

Selecting Enter will allow the operator to safely remove the Memory Card.

Arrow Down

```
EJECT MEMORY CARD
* INFO
MAIN MENU
EXIT
```

Selecting Enter at UNIT INFO displays the following:

```
3100 UNIT INFO:
SN- XXXXXXXXXXXXXXXXX
VER- X   X.XXX.XXX
```

SN is the SEC 3100 serial number. VER is the SEC 3100 software version number. Selecting Enter again will return the display to the main info menu.

Sensor Status Menu

TYP: Sensor type (0.0 is a SEC 3000, 32.0 is SEC Millenium)

SN: Sensor serial number.

VER: Version of sensor software.

CAL: Calibration date of sensor.

Selecting MAIN MENU is covered in the next pages of the manual.

Select Exit to go back to

```
EJECT MEMORY CARD
INFO
MAIN MENU
* EXIT
```

Main Menu and Sub Menus

EJECT MEMORY CARD
INFO
* MAIN MENU
↓

Enter

* CALIBRATION
ALARM
RELAY
↓

Calibration Menu

Used to calibrate the gas sensor.

Down Arrow

CALIBRATION
* ALARM
RELAY
↓

Alarm Menu

Used to set alarm level set points and parameters.

Down Arrow

CALIBRATION
ALARM
* RELAY
↓

Relay Menu

For setting alarm relay On & Off delay & Energized states.

Down Arrow

↑
* NETWORK
HIDE NO
↓

Network Menu

Used to set Zone #, ID # and Select Online

Down Arrow

↑
NETWORK
* HIDE NO
↓

Hide Menu

Hide is used to blank the display up to low alarm setting

Down Arrow

↑
* SELF TEST
DATE TIME
↓

Self Test Menu

Generates a signal on the display, RS485 & 4-20 mA

Down Menu

↑
SELF TEST
* DATE TIME
↓

Date Time Menu

Sets the date and time in the real time clock.

Down Arrow

* 4 – 20 MA CAL
EXIT

4 – 20 MA CAL

Allows user to increase or decrease 4.0 mA current output, or adjust 20 mA current output

Down Arrow

↑
4 – 20 MA CAL
* EXIT

Exit back to normal operation.

Calibration Menu

```
* CALIBRATION
ALARM
RELAY
↓
Enter
```

Using the Up and Down arrows allows the operator to move the cursor (*) to select a function.

```
* ZERO          0
SPAN
CAL. VAL
EXIT
```

To Zero the sensor apply clean air (N2 for an oxygen sensor) and select enter. The following will be displayed.

```
CALIBRATION PROCESS
----- WAIT -----
```

Then the following will be displayed.

```
CALIBRATION PROCESS
----- DONE -----
```

Once complete the following will be displayed. The sensor has been successfully zeroed.

```
* ZERO          0
SPAN
CAL. VAL
EXIT
```

Arrow down to CAL. VAL to verify the span gas calibration value matches the value of the span gas calibration on hand. If not, select Enter and the following screen will appear.

```
ZERO
SPAN
* CAL. VAL  5      *
EXIT
```

Using the Up and Down arrows will allow the operator to change the calibration gas value of the sensor to match the calibration gas used to span the sensor. Once the correct value is displayed select Enter and the sensor will be uploaded with the new calibration gas value.

To Span the sensor with calibration gas use the Up and Down arrows to select the following display.

```
ZERO          3
* SPAN
CAL. VAL
EXIT
```

Apply span gas to the sensor for the appropriate amount of time in order for the sensor to stabilize. The gas reading is displayed to the right of ZERO. Once stable select Enter. This will go the display:

```
CALIBRATION PROCESS
----- DONE -----
```

If calibration span gas is still present the display will read:

```
GAS LEVEL : 5
CALIB. GAS PRESENT
--- WAIT ---
```

Apply clean air to the sensor to reduce this reading. The display will advance to the following:

```
* ZERO          0
SPAN
CAL. VAL
EXIT
```

This completes the calibration and the device can be put back into the normal operating mode. Arrow Down to

```
ZERO
SPAN
CAL. VAL
* EXIT
```

Enter

```
↑
* EXIT
```

Enter again and the SEC 3100 returns to normal operation.

Alarm Menu

CALIBRATION
* ALARM
RELAY
↓

Enter

* LOW
MID
HI
↓

↑
* FAULT
EXIT

Select the Alarm Relay (LOW, MID, HI, FAULT) using the down arrow. Once the cursor is on the alarm relay you wish to configure, hold the magnet over Enter. The example LOW will be used. The same operations can be used to set the MID, HI or FAULT relays.

* ALARM LOW 4
LATCH
ACTIVE
EXIT

Selecting Enter will display the following screen allowing the alarm set point to be programmed. Using the Up and Down arrows will change the set point. Once the correct set point is displayed select Enter and the new value will be accepted.

* ALARM LOW 2 *
LATCH
ACTIVE
EXIT

CONFIGURING PROCESS
----- WAIT -----

* ALARM LOW 2
LATCH
ACTIVE
EXIT

Arrow Down

ALARM LOW
* LATCH NORMAL
ACTIVE
EXIT

Selecting Enter will allow the operator to change the operation of the relay operation from Non-Latching (NORMAL) to Latching (LATCHING) or to Audible (AUDIBLE).

If the relays are set to Latching or Audible, the magnet can be used to reset (unlatch or silence) the relays by selecting any magnetic pickup switch UP arrow, DOWN arrow or ENTER.

Arrow Down

```
ALARM LOW
LATCH
* ACTIVE      HI
EXIT
```

Selecting Enter will allow the operator to change the operation of the relay operation from Active HI to Active LOW. HI activates the relay on a rising alarm level. LOW activates the relay when the alarm threshold falls below the alarm set point. Once the correct operation is selected, use the Down arrow to advance to the next menu item.

Arrow Down

```
ALARM LOW
LATCH
ACTIVE
* EXIT
```

Selecting Exit will advance to the next menu.

```
* LOW
MID
HI
↓
```

This menu will allow the operator to select another relay to program. Or select Fault or Exit and the next display will be:

```
↑
FAULT
* EXIT
```

Selecting Enter on this display will put the SEC 3100 back into normal operation.

Relay Menu

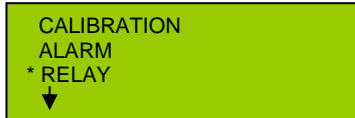

Selecting Enter will advance to the following menu.



Arrow down to the next screen will be



Select the Alarm Relay (LOW, MID, HI, FAULT) that is to be configured using the down arrow. Once the cursor is on the correct alarm relay, hold the magnet over Enter. The example LOW will be used. The same operations can be used to set the MID, HI, or FAULT relays.



Select Enter

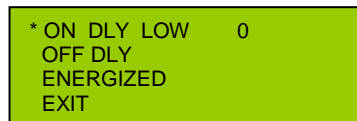

Select Enter

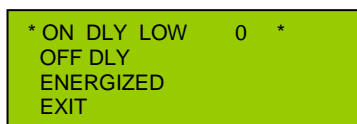

Using the Up and Down arrows the operator can change the ON delay time for the relay to actuate after the alarm threshold has been exceeded. The time is measured in seconds (0-255). Once the correct time is displayed select Enter to accept the new value. Then Exit the menu and proceed on to the next selection.

In this example the Low alarm relay will actuate 30 seconds after the Low set point is exceeded.

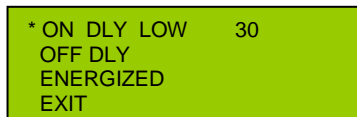

Select Enter

```
ON DLY LOW
* OFF DLY      0
ENERGIZED
EXIT
```

Select Enter

```
ON DLY LOW
* OFF DLY      0 *
ENERGIZED
EXIT
```

Using the Up and Down arrows the operator can change the OFF delay time for the relay to turn OFF after the reading has decreased below the alarm point threshold. The time is measured in seconds (0-255). Once the correct time is displayed select Enter to accept the new value. Then Exit the menu and proceed on to the next selection.

In this example the Low alarm relay will stay energized for 60 seconds after the alarm has cleared.

```
ON DLY LOW
* OFF DLY      60
ENERGIZED
EXIT
```

Arrow Down

```
ON DLY LOW
OFF DLY
* ENERGIZED NO
EXIT
```

Selecting Enter will allow the operator to change the operation of the relay coil from normally de-energized (ENERGIZED NO) to normally energized (ENERGIZED YES). Once the correct operation is selected, use the Down arrow to advance to the EXIT menu. Select Enter to go back to the Relay Menu

```
* LOW
MID
HI
↓
```

This menu will allow the operator to select another relay to program. Or select Exit and the next display will be:

```
↑
* FAULT
EXIT
```

Arrow Down to Exit

```
↑
FAULT
* EXIT
```

Enter

```
↑
* EXIT
```

Selecting Enter will return the SEC 3100 into normal operation.

Network Menu

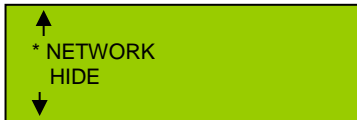

Select Enter

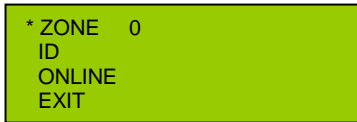

Select Enter to change the Zone number of the SEC 3100.

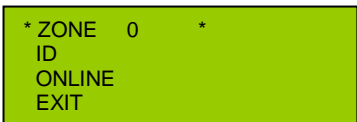

Use the Up and Down Arrows change the Zone number (0-255). Once the correct Zone number is displayed select Enter.

Arrow Down to ID. To change the ID number select Enter. Use the Up and Down Arrows to change the ID number (0-255). Once the correct ID number is displayed select Enter.

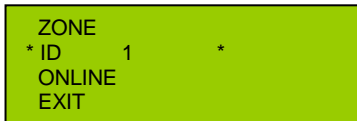

Arrow Down to Online.



Using Enter the operator can toggle between Online YES and Online NO. Online YES turns on the MODBUS RS485 communication. Online NO turns the MODBUS RS485 communication off.

Arrow Down to Exit



Enter



Hide Menu

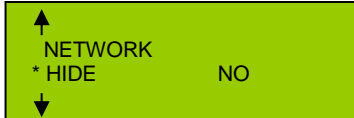

Using Enter the operator can toggle between Hide YES and Hide NO. The Hide function allows the operator to not display the gas reading until the Low Alarm threshold is exceeded. All outputs will function as normal when the Hide mode selected to YES.

Self Test Menu

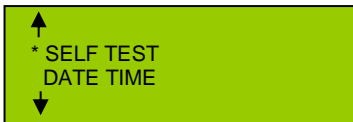

Selecting Enter for the Self Test will make the sensor generate a 4-20 mA input into the SEC 3100 from 4 mA to 20 mA (0-fullscale). In the self test mode the SEC 3100 outputs are fully functional. The SEC 3100 will display the rising gas level, the 4-20 mA output will increase to 20 mA, the relays will actuate and the RS485 information will be transmitted to the control system. The following screen will be displayed

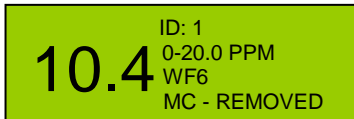

Once the unit reaches full scale the SEC 3100 automatically returns to normal.

Time Date Menu



Entering this menu will allow the operator to set the time and date of the SEC 3100 real time clock.

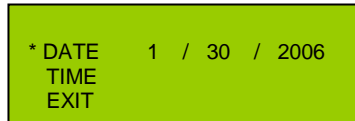

Selecting Enter will locate a cursor (*) above the number allowing the operator to use the Up Down arrows to increase or decrease the numbers. Once the correct number is displayed, select Enter with the magnet and the cursor will advance to the next number.

Date is MM/DD/YYYY. Time is HH/MM/SS. Below is an example.

Enter from above display.

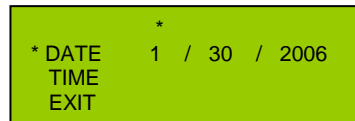

Arrow Up one number.

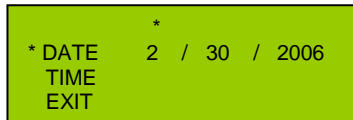

Enter

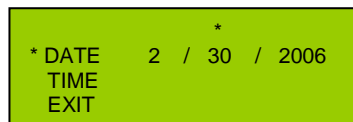

Continue with the sequence until the correct date appears. Then select Enter and the following will be displayed.

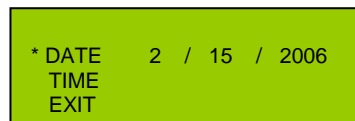

At this point the operator can advance to setting the correct time using the Down Arrow.

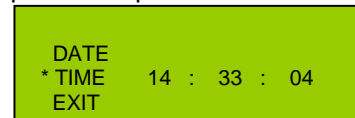

Time numbers are changed using the procedure as the Date numbers. Once the correct Time is programmed, select Enter and arrow down to Exit.



Select Enter



Selecting Enter again will return the SEC 3100 to normal operation.

4 – 20 MA CAL Menu

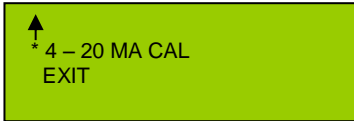

The 4 – 20 MA CAL Menu will allow the operator to increase or decrease the 4 to 20 mA output current at 4.0 mA and at 20 mA. *Typically this menu is not often used in the field because the analog signals are set at the factory.*

Selecting Enter will display the following:

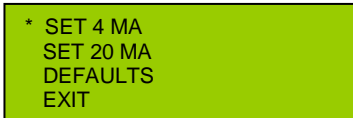

Selecting Enter will display the following:

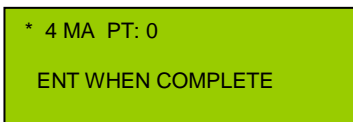

Using the UP / DOWN arrows will increase (UP arrow) or decrease (DOWN arrow) the number. Increasing the number will raise the 4.0 mA current output, lowering the number will decrease the 4.0 mA number. Note the number can be set to a negative number (-2 etc). Once the correct current output is set, pass the magnet over the ENTER Arrow and this will accept the new settings.

The display will be the following:

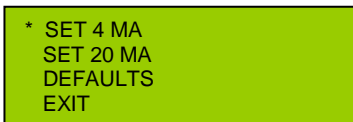

To adjust the full scale 20 mA current output arrow down and select ENTER:

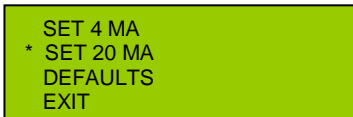

Using the UP / DOWN arrows will increase (UP arrow) or decrease (DOWN arrow) the number. Increasing the number will raise the 20.0 mA current output, lowering the number will decrease the 4.0 mA number. Note the number can be set to a negative number (-2 etc). Once the correct current output is set, pass the magnet over the ENTER Arrow and this will accept the new settings.

Arrow down to this display and select ENTER to clear all user set numbers. Both 4 MA and 20 MA will return to 0

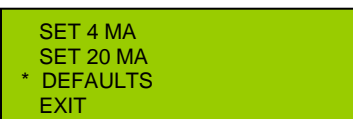

Arrow down and select Enter to return to the SEC 3100 to 4-20 MA CAL main menu..

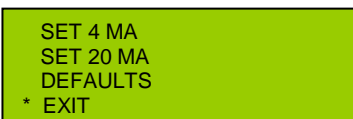

V. FIGURES

Figure 1 – Overall Layout

Figure 2 – SEC 3100 Wiring

Figure 3 – SEC Sensor Separation Kit

Figure 4 – Mounting SEC 3100 and SEC Millenium

Figure 5 – Mounting SEC 3100 and SEC 3000

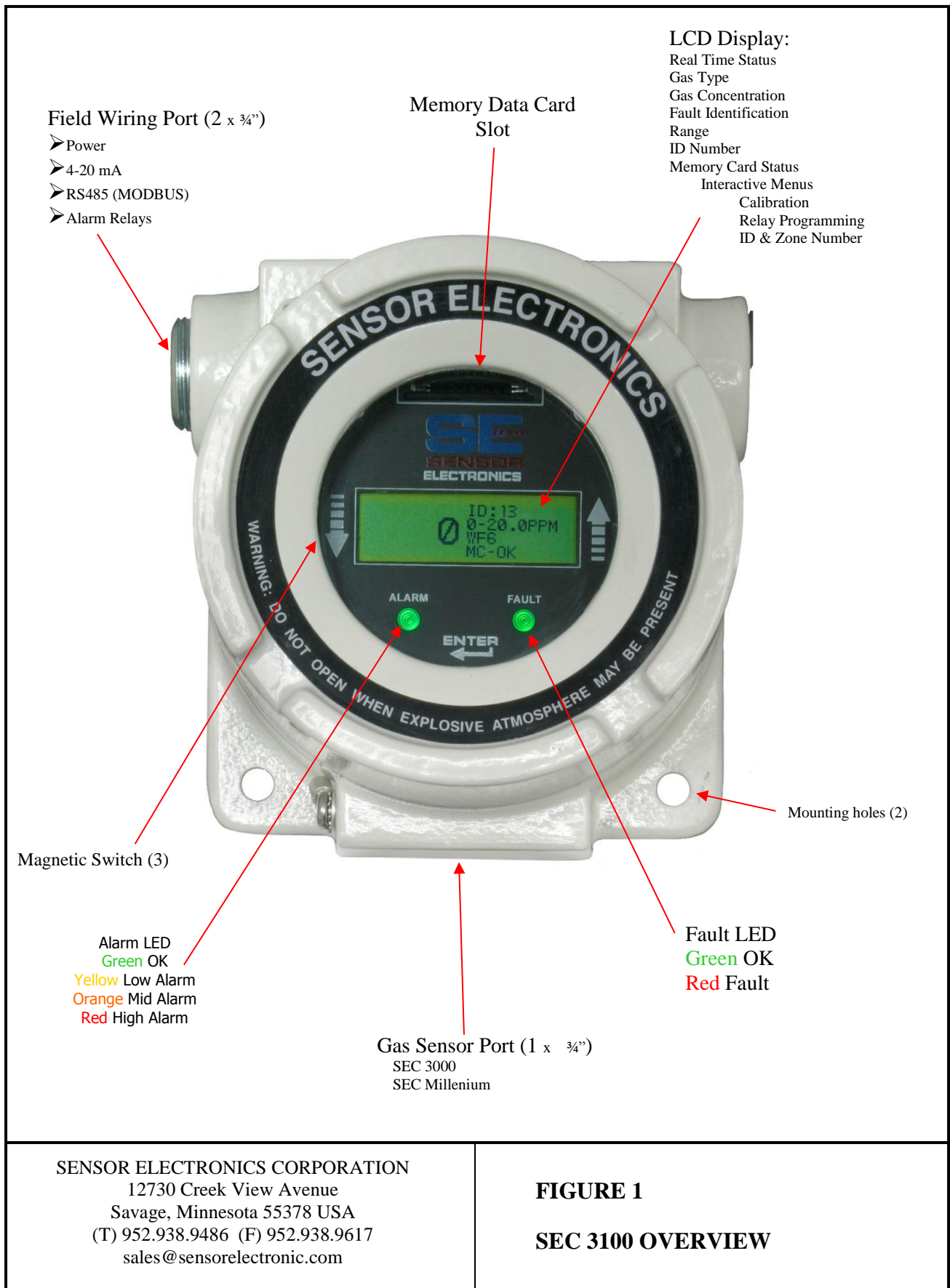

LCD Display:
 Real Time Status
 Gas Type
 Gas Concentration
 Fault Identification
 Range
 ID Number
 Memory Card Status
 Interactive Menus
 Calibration
 Relay Programming
 ID & Zone Number

Field Wiring Port (2 x 3/4")
 ➤ Power
 ➤ 4-20 mA
 ➤ RS485 (MODBUS)
 ➤ Alarm Relays

Memory Data Card Slot

WARNING: DO NOT OPEN WHEN EXPLOSIVE ATMOSPHERE MAY BE PRESENT

Mounting holes (2)

Magnetic Switch (3)

Alarm LED
 Green OK
 Yellow Low Alarm
 Orange Mid Alarm
 Red High Alarm

Fault LED
 Green OK
 Red Fault

Gas Sensor Port (1 x 3/4")
 SEC 3000
 SEC Millennium

SENSOR ELECTRONICS CORPORATION
 12730 Creek View Avenue
 Savage, Minnesota 55378 USA
 (T) 952.938.9486 (F) 952.938.9617
 sales@sensorelectronic.com

FIGURE 1
SEC 3100 OVERVIEW

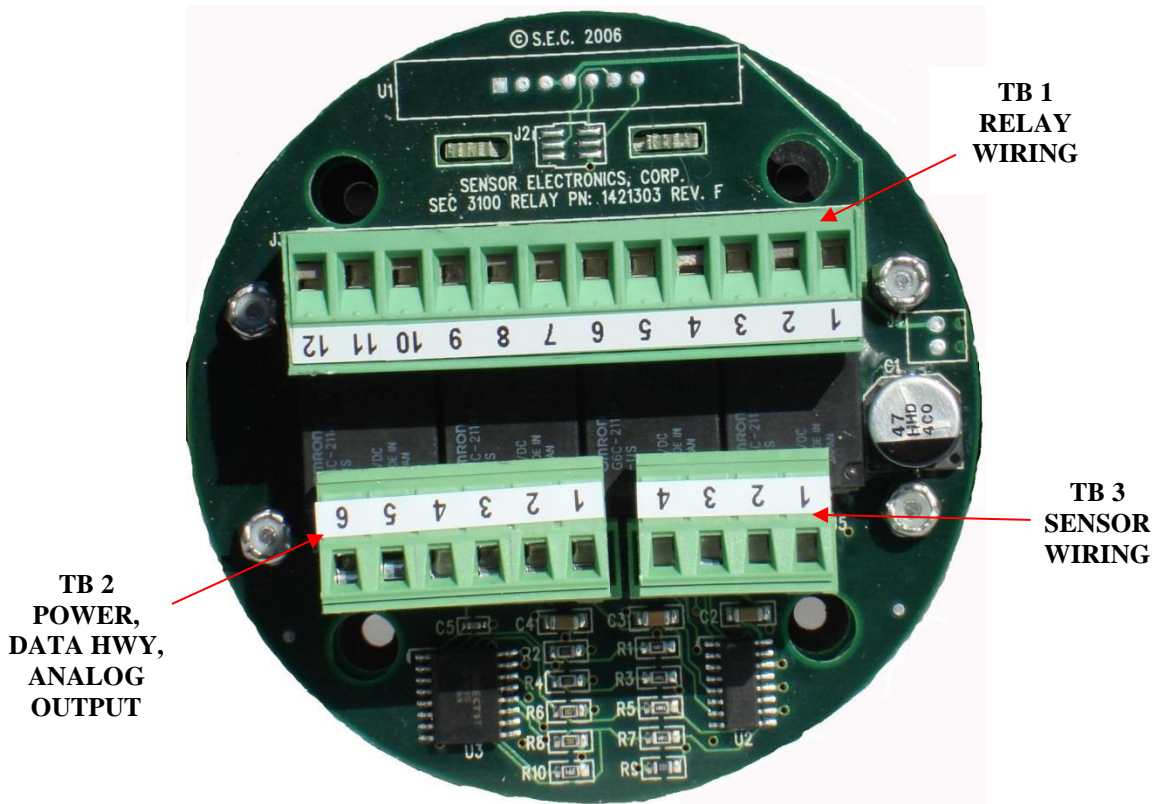

**TB 2
POWER,
DATA HWY,
ANALOG
OUTPUT**

**TB 1
RELAY
WIRING**

**TB 3
SENSOR
WIRING**

- TB 1**
- (12) LOW ALARM N.C.
 - (11) LOW ALARM COMMON
 - (10) LOW ALARM N.O.
 - (9) MID ALARM N.C.
 - (8) MID ALARM COMMON
 - (7) MID ALARM N.O.
 - (6) HIGH ALARM N.C.
 - (5) HIGH ALARM COMMON
 - (4) HIGH ALARM N.O.
 - (3) FAULT (N.E.) N.C.
 - (2) FAULT (N.E.) COMMON
 - (1) FAULT (N.E.) N.O.

- TB 2**
- (1) 4-20 mA ANALOG OUTPUT
 - (2) DC COMMON
 - (3) +24 VDC
 - (4) DATA ISO COMMON
 - (5) RS485 DATA B
 - (6) RS485 DATA A

- TB 3**
- (1) WHITE
(DATA/CAL)
 - (2) BLUE OR GREEN
(4-20 mA)
 - (3) RED
(+24 VDC)
 - (4) BLACK
(DC COMMON)

SENSOR ELECTRONICS CORPORATION
12730 Creek View Avenue
Savage, Minnesota 55378 USA
(T) 952.938.9486 (F) 952.938.9617
sales@sensorelectronic.com

FIGURE 2
BACK VIEW OF SEC 3100
SEC 3100 WIRING

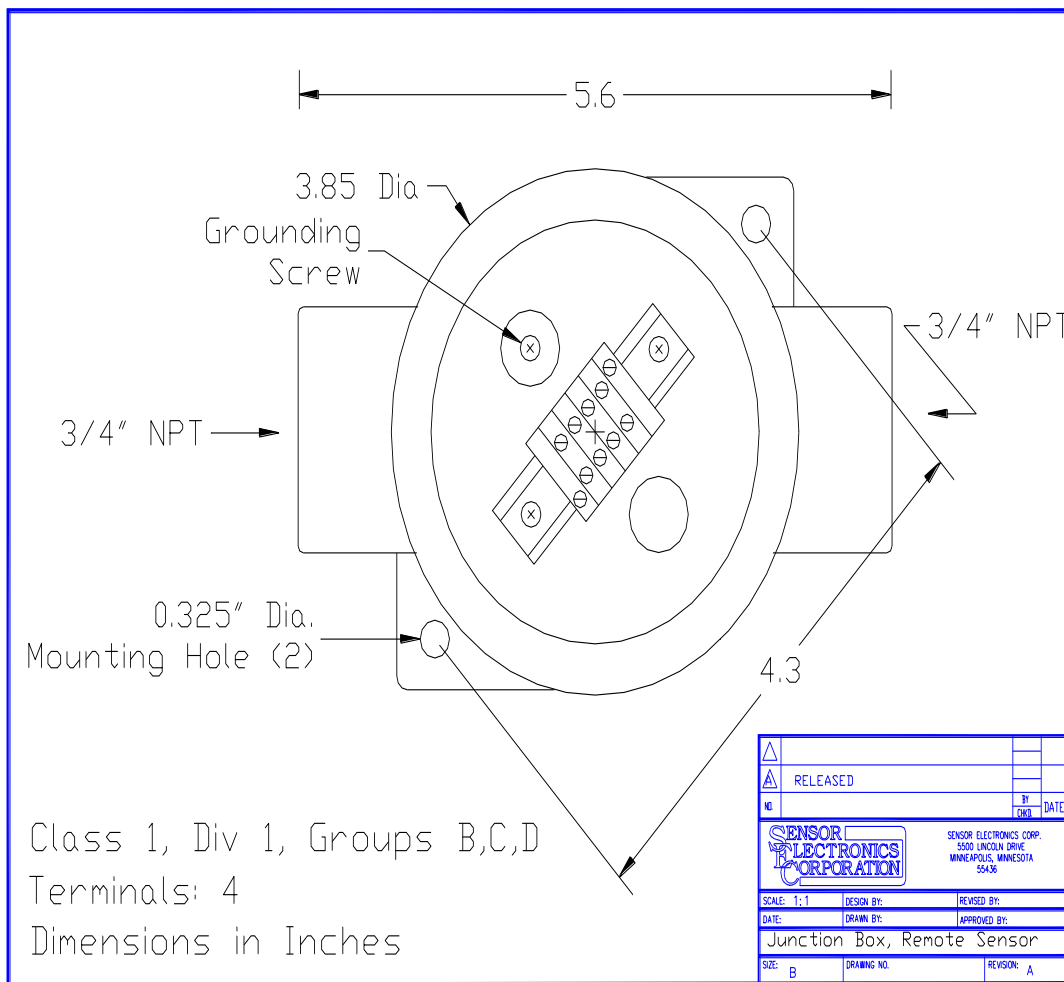

SENSOR ELECTRONICS CORPORATION
 12730 Creek View Avenue
 Savage, Minnesota 55378 USA
 (T) 952.938.9486 (F) 952.938.9617
 sales@sensorelectronic.com

FIGURE 3
SEC SENSOR SEPARATION KIT

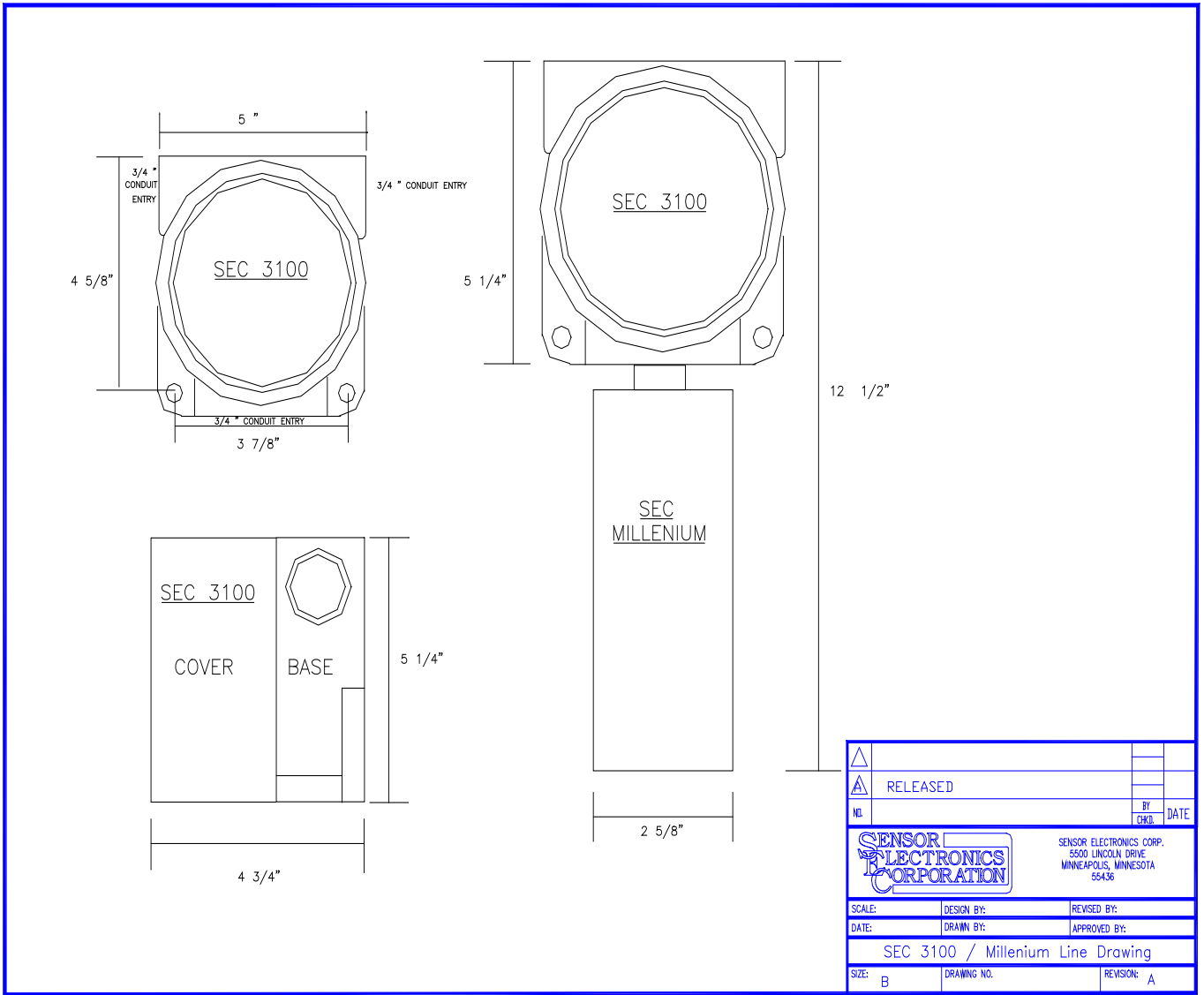
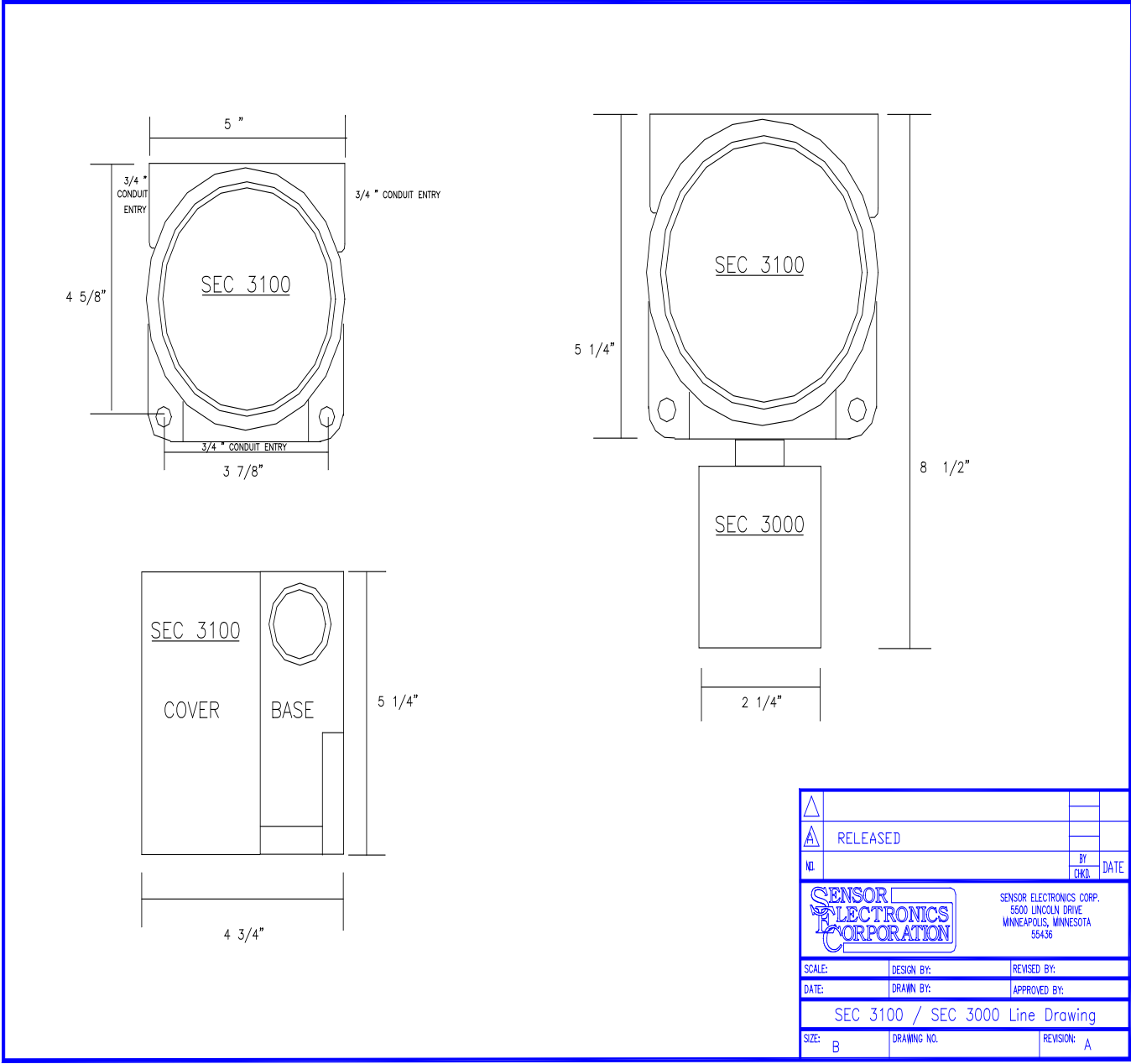

FIGURE 4
SEC 3100 – SEC Millenium Mounting



RELEASED		BY	DATE
NO.		CHKD.	
		SENSOR ELECTRONICS CORP. 5500 LINCOLN DRIVE MINNEAPOLIS, MINNESOTA 55436	
SCALE:	DESIGN BY:	REVISED BY:	
DATE:	DRAWN BY:	APPROVED BY:	
SEC 3100 / SEC 3000 Line Drawing			
SIZE: B	DRAWING NO.	REVISION: A	

FIGURE 5
SEC 3100 – SEC 3000 Mounting