



SEC *Signature* Process Gas Analyzer

Features

- *Capable of continuous monitoring for gas vapors*
- *Low cost*
- *Infrared sensing technology*
- *Designed for nonextractive sampling installation*
- *Virtually maintenance free*
- *Explosion proof*
- *Immune to poisoning and etching*
- *Designed for harsh environments*
- *Compact and lightweight*
- *Fast response time*
- *Simple calibration*
- *Self-compensating optical bench (patented)*
- *Linear output*
- *Unaffected by humidity and pressure*
- *Heated optical chamber*
- *Low power consumption*
- *Operates in anaerobic atmospheres*
- *Continual self diagnostics*
- *4 to 20 mA output*

Operation / Description

The SEC *Signature* is a self-contained optical gas analyzer designed for non-intrusive continuous monitoring of process gases. The infrared optical system is self-compensating for most aging, environmental, and contamination effects resulting in excellent measurement integrity. An industry standard analog output provides complete remote alarm, fault and calibration signals. The analog output from the device can be connected to chart recorders, data acquisition systems or a process control system.

The SEC *Signature* measures infrared light absorption due to molecular resonances. The monitor is tuned to the infrared signature of the target gas or vapor, measuring light at wavelengths absorbed by the target gas and at wavelengths not absorbed by the target gas. The gas concentration is determined by calculating the ratios of the analytical and reference levels. Embedded linearization algorithms keep the output accurate over the entire measuring range and embedded compensation algorithms maintain measuring accuracy over changing environmental conditions.

The SEC *Signature* employs a reliable, directly opposed optical system. No mirrors or reflecting surfaces are used in this device. The anodized aluminum surfaces of the optical chamber are heated to discourage condensation. Sapphire windows protect the optics eliminating the corrosive effects found in many process monitoring applications.

Once the unit is spanned to a specific mid range gas concentration (a one time operation), routine calibration consists of only rezeroing the device periodically.

Dimensions

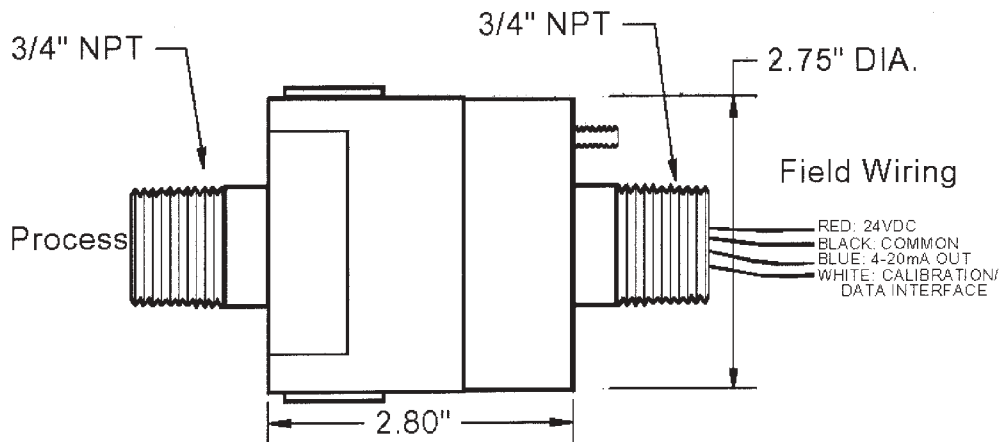

Specifications

Range (adjustable): EtO 0-2000mg/liter
 Hydrocarbon 0-100% VOL
 CO2 0-20% VOL

Model: EtO P/N 142-0597
 Hydrocarbon P/N 142-1014
 CO2 P/N 142-0848

Construction: Anodized aluminum and sapphire

Mechanical Connection: 3/4" NPT

Weight: 18 ounces

Accuracy: $\pm 5\%$ of reading or $\pm 3\%$ full scale
 (Whichever is greater)

Repeatability: $\pm 2\%$

Operating Voltage: 18 - 32 VDC $\overline{=}$

Max. Power Consumption: 6 watts

Current Draw (@24 VDC): 250 mA (average)
 450 mA (peak)

Analog Output: 0-20 mA (sourced)

Digital Output: Interactive P.C. link

Wire Connections: Red wire (+ 24 VDC) $\overline{=}$
 Black wire (D.C. common)
 Blue wire (4-20 mA output signal)
 White wire (Calibration / digital interface)

Approvals: CSA, CE

Rating: Class 1, Div 1, Groups B,C,D
 (-40C to 50C)

Humidity: 0-99% (Non-condensing)

Operating Temperature: 0-65° C

Operating Pressure: 1 PSIA - 55 PSIA

Installation Category: Cat. 1, Pollution
 Degree 2

Current Output	Status
4-20 mA	Normal measuring mode
0.0 mA	Unit Fault
0.2 mA	Reference channel fault
0.4 mA	Analytical channel fault
0.8 mA	Unit warm up
1.0 mA	Optics fault
1.2 mA	Zero drift fault
1.6 mA	Calibration fault
2.0 mA	Unit spanning
2.2 mA	Unit zeroing
4.0 mA	Zero gas level
5.6 mA	10% Full Scale
8.0 mA	25% Full Scale
12 mA	50% Full Scale
16 mA	75% Full Scale
20 mA	Full Scale
>20 mA	Over-range

Sensor Electronics Corporation

5500 Lincoln Drive, Minneapolis, Minnesota 55436 U.S.A. • (800) 285-3651 • (952) 938-9486 • FAX: (952) 938-9617
 Email: sales@sensorelectronic.com • website: www.sensorelectronic.com